

TECHNICAL INFORMATION BULLETIN

LAMP AND BALLAST KIT

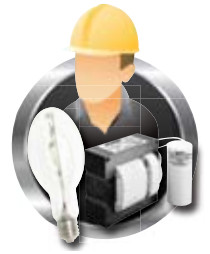

Ordering Information

Order code: 61713

ANSI code: S62

Description: LBK/BHPS0070/QUADTAP/C/HX/MOG

System: High Pressure Sodium

UPC: 69549617131

Ballast Information

Line Voltage	120/208/240/277V
Regulation	
Line Volts	+/- 5%
Line Watts	WITHIN TRAPEZOID
Frequency	60 Hz
Circuit Type	HX-HPF
Power Factor (min)	90%
Insulation Class	H(180°)
Min. Ambient Starting Temp.	-40° F or -40° C

Line Voltage (Volts)	120	208	240	277
Line Current (Amps)				
Operating	0.82	0.48	0.41	0.36
Open Circuit	1.425	0.85	0.72	0.62
Starting	0.80	0.50	0.40	0.35
Input Watts (W)	91	91	91	91
Open Circuit Voltage (V)	120	120	120	120
Drop Out Voltage (V)	96	166	192	222
UL(1029) Bench Top Rise	A	A	A	A
Recommended Fuse (Amps)	5	3	2	2
HIGH POTENTIAL TEST (VOLTS)				
1 Minute	2000			
2 Seconds	2500			
Open Circuit Voltage Test (volts)	110-135			
Short-Circuit Current Test (Amps)				
Secondary Current	1.80 - 2.20			
Input Current (Amps)	0.55 - 0.85	0.30 - 0.50	0.25 - 0.45	0.30 - 0.35

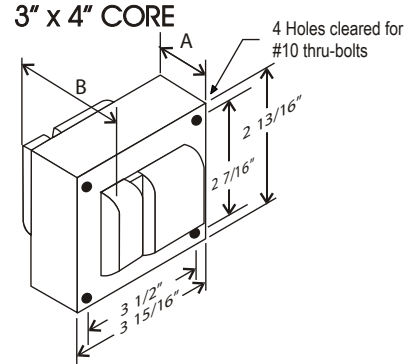

CORE AND COIL

Dimension A (inches)	1.50
Dimension B (inches)	2.80
Weight (Lbs)	6.00
Lead Lengths (inches)	12

CAPACITOR

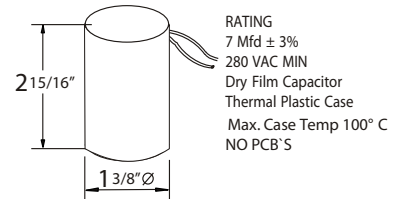

IGNITOR

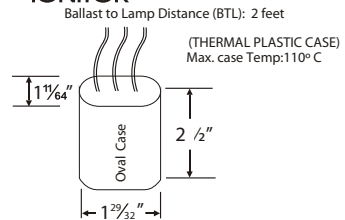

WIRING DIAGRAM

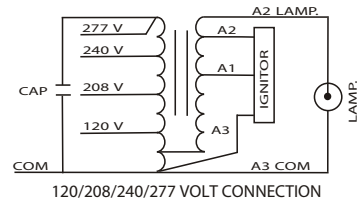

BRACKET CORE & COIL MOUNTING BRACKET

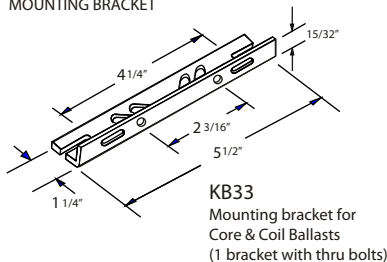

C-01
MOUNTING CLIP for round case (Furnished as standard with B suffix ballast)

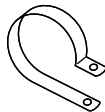

I-01
MOUNTING CLIP for oval case (Furnished as standard with B suffix ballast)

WARRANTY:

Ballast warranty of 3 years. For more information visit our website.



Data is based upon tests performed in a controlled environment and representative of relative performance. Actual performance can vary depending on operating conditions. Specifications are subject to change without notice.



www.standardpro.com

TECHNICAL INFORMATION BULLETIN

LAMP AND BALLAST KIT

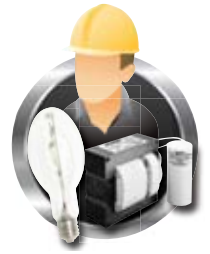

Ordering Information

Order code: 61713

ANSI code: S62

Description: LBK/BHPS0070/QUADTAP/C/HX/MOG

System: High Pressure Sodium

UPC: 69549617131

Lamp Information

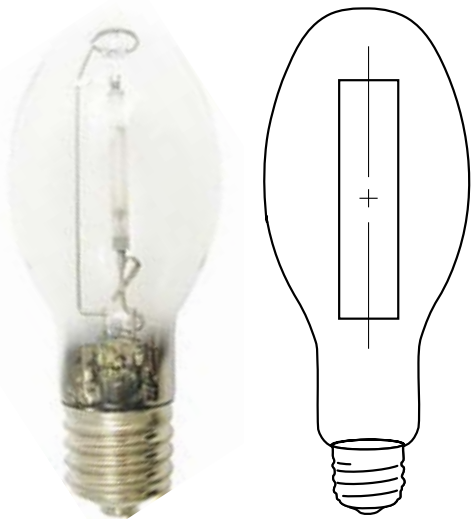

Wattage (W):	70
Initial lumens (lm):	6 300
Mean lumens (lm):	5 500
Lumens per watt (lm/W):	90
Lamp voltage (V):	52
Colour temperature (K):	1 900
Chromaticity (x,y):	0.525, 0.415
CRI:	22
Average life (hrs):	24 000
Warm up time to 90% (min):	5
Hot restart time to 90% (min):	3
Burn Position:	Universal
Max base temperature:	210
Max lamp temperature:	400

ALL
TOUTES

Spectral Distribution

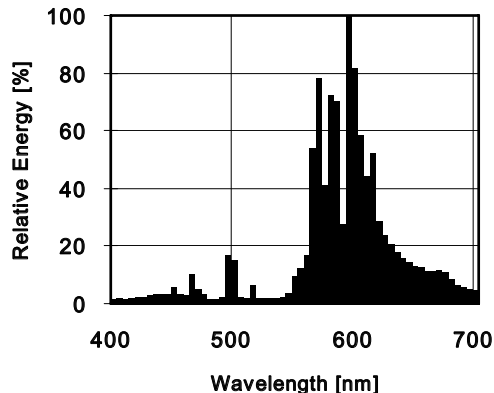

Physical data / Requirements

Shape:	ED23.5
Base:	Mog Base E39
Finish:	Clear
Luminaire rating:	Open
Diameter (mm/in.):	75.0 (2 15/16)
MOL (mm/in.):	186.0 (7 5/16)
LCL (mm/in.):	127.0 (5)
Effective arc length (mm):	27

Warning

“R” **WARNING:** this lamp can cause serious skin burn and eye inflammation from shortwave ultraviolet radiation if the outer envelope of the lamp is broken or punctured. Do not use where people will remain for more than a few minutes unless adequate shielding or other safety precautions are used. Lamps that will automatically extinguish when the outer envelope is broken or punctured are commercially available. Complies with USA Federal Standard 21 CFR 1040.30 and Canada Standard SOR/80-381.