

# TECHNICAL INFORMATION BULLETIN

## LAMP AND BALLAST KIT



### Ordering Information

Order code: 61716

ANSI code: S55

Description: LBK/BHPS0150/QUADTAP/C/HX/MED

System: High Pressure Sodium

UPC: 69549617162

### Ballast Information

Line Voltage	120/208/240/277V
Regulation	
Line Volts	+/- 5%
Line Watts	WITHIN TRAPEZOID
Frequency	60 Hz
Circuit Type	HX-HPF
Power Factor (min)	90%
Insulation Class	H(180°)
Min. Ambient Starting Temp.	-40° F or -40° C

Line Voltage (Volts)	120	208	240	277
Line Current (Amps)				
Operating	1.66	0.96	0.83	0.72
Open Circuit	2.81	1.65	1.45	1.25
Starting	1.80	1.05	0.86	0.80
Input Watts (W)	188	188	188	188
Open Circuit Voltage (V)	120	120	120	120
Drop Out Voltage (V)	96	166	192	222
UL(1029) Bench Top Rise	C	B	B	B
Recommended Fuse (Amps)	10	5	5	4
HIGH POTENTIAL TEST (VOLTS)				
1 Minute	2000			
2 Seconds	2500			
Open Circuit Voltage Test(volts)	110-135			
Short-Circuit Current Test (Amps)				
Secondary Current	3.6 - 4.6			
Input Current (Amps)	1.25 -	0.70 -	0.60 -	0.52 -
	2.30	1.30	1.15	1.00

### 3" x 4" CORE

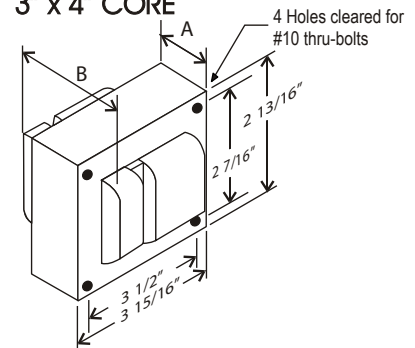

### CORE AND COIL

Dimension A (inches)	2.50
Dimension B (inches)	3.875
Weight (Lbs)	8.00
Lead Lengths (inches)	12

### CAPACITOR

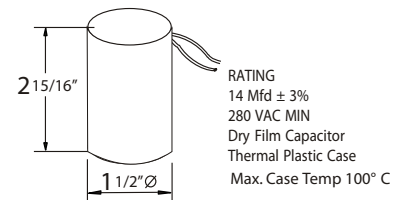

### IGNITOR

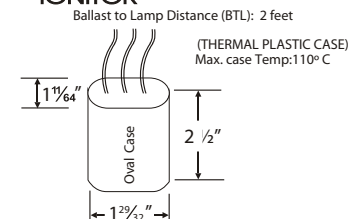

### WIRING DIAGRAM

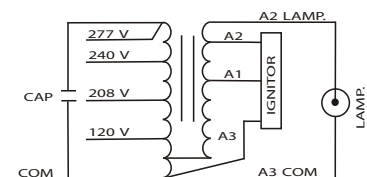

120/208/240/277 VOLT CONNECTION

### BRACKET

CORE & COIL  
MOUNTING BRACKET

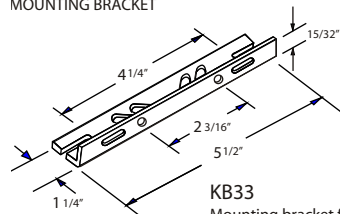

KB33  
Mounting bracket for  
Core & Coil Ballasts  
(1 bracket with thru bolts)

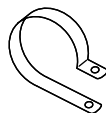

C-01  
MOUNTING CLIP for round  
case (Furnished as standard  
with B suffix ballast)

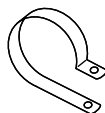

I-01  
MOUNTING CLIP for oval  
case (Furnished as standard  
with B suffix ballast)

### WARRANTY:

Ballast warranty of 3 years. For more information visit our website.



Data is based upon tests performed in a controlled environment and representative of relative performance. Actual performance can vary depending on operating conditions. Specifications are subject to change without notice.



www.standardpro.com

# TECHNICAL INFORMATION BULLETIN

## LAMP AND BALLAST KIT



### Ordering Information

Order code: 61716

ANSI code: S55

Description: LBK/BHPS0150/QUADTAP/C/HX/MED

System: High Pressure Sodium

UPC: 69549617162

### Lamp Information



Wattage (W):	150
Initial lumens (lm):	15 800
Mean lumens (lm):	13 400
Lumens per watt (lm/W):	105
Lamp voltage (V):	55
Colour temperature (K):	2 100
Chromaticity (x,y):	0.525, 0.415
CRI:	22
Average life (hrs):	24 000
Warm up time to 90% (min):	5
Hot restart time to 90% (min):	3
Burn Position:	Universal
Max base temperature:	190
Max lamp temperature:	400



### Spectral Distribution

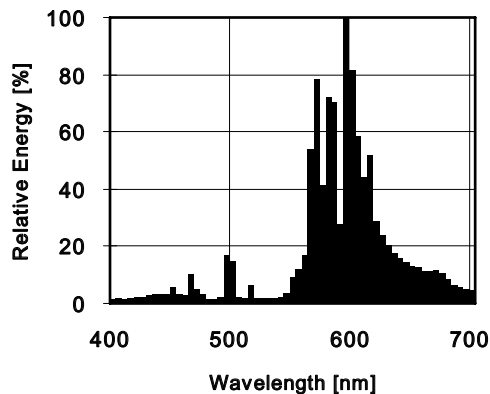

### Physical data / Requirements

Shape:	ED17
Base:	Med Base E26
Finish:	Clear
Luminaire rating:	Open
Diameter (mm/in.):	54.0 (2 1/8)
MOL (mm/in.):	139.0 (5 15/32)
LCL (mm/in.):	86.0 (3 3/8)
Effective arc length (mm):	40

### Warning

“R” **WARNING:** this lamp can cause serious skin burn and eye inflammation from shortwave ultraviolet radiation if the outer envelope of the lamp is broken or punctured. Do not use where people will remain for more than a few minutes unless adequate shielding or other safety precautions are used. Lamps that will automatically extinguish when the outer envelope is broken or punctured are commercially available. Complies with USA Federal Standard 21 CFR 1040.30 and Canada Standard SOR/80-381.

