

Date: _____
 In hands date of project: _____
 Project name/Number: _____
 Name of distributor: _____
 Client #: _____
 Name of end user: _____

ORDERING INFORMATION

Order code: 65947
 Description: LPDL6/S2/RND/12W/40K/WH/STD
 UPC: 69549659476
 Case quantity: 24

PERFORMANCE DATA

Shape: Round
 Type: LED LPDL 6"
 Lens type: PS (Acrylic)
 Trim finish: White
 Wattage (W): 12
 Voltage (VAC): 120
 Beam angle: 120°
 Color temperature (K)**: 4 000
 Lumens (lm)*: 800
 Lumens per watt (lm/W): 67
 Life (hours): 50 000
 CRI: 80
 Dimming type: Forward phase
 THD (%): <40
 Power factor: >0.9
 Operating temperature range: - 20 °C / - 4 °F to 45 °C / 113 °F



*Initial lumens range: +/- 5 % **Typical colour temperature range: +/- 5 %



TECHNICAL DRAWINGS

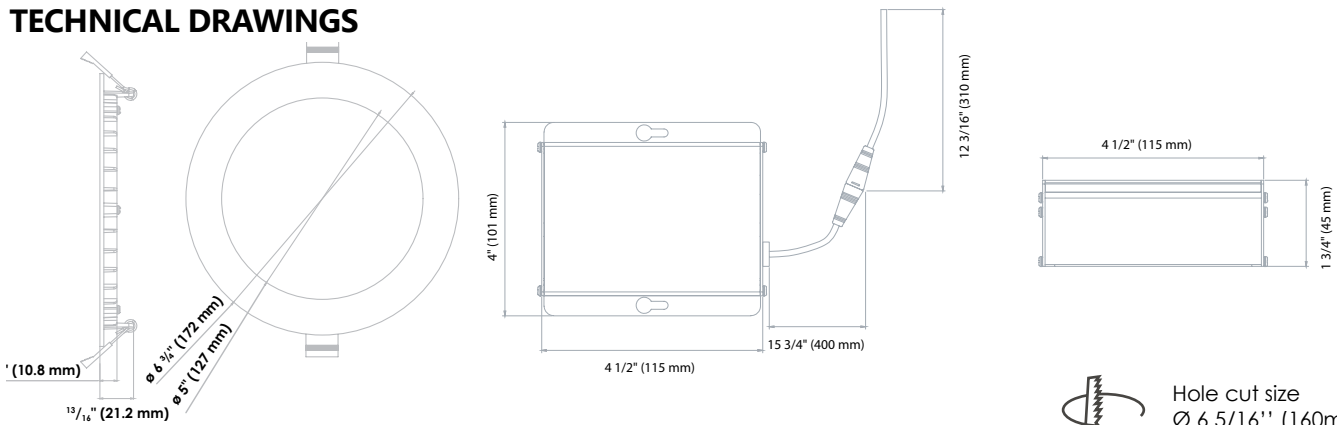

CAN ICES-005 (B) - This lighting equipment complies with Canadian standard ICES-005 for use in residential applications. For a complete list of ENERGY STAR qualified products, please visit www.standardpro.com. Data is based upon tests performed in a controlled environment and representative of relative performance. Actual performance can vary depending on operating conditions. Specifications are subject to change without notice.

ORDERING INFORMATION

Order code: 65947
 Description: LPDL6/S2/RND/12W/40K/WH/STD
 UPC: 69549659476
 Case quantity: 24

PHOTOMETRICS - BEAM SPREAD*

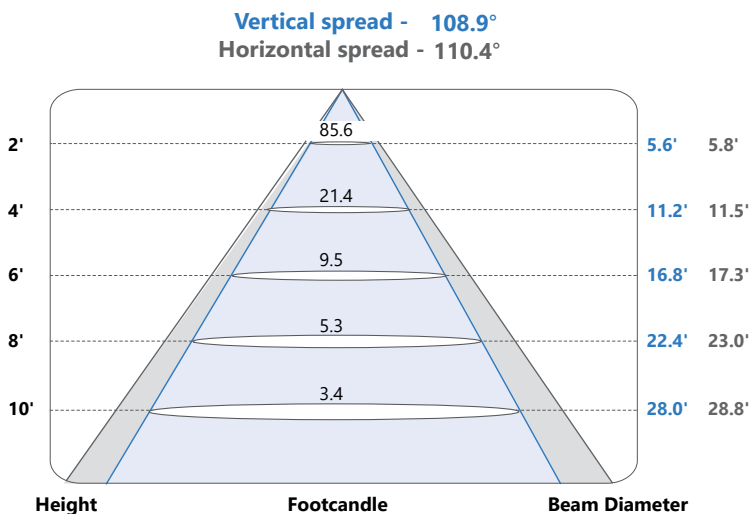

* complete IES files available on our website.

COMPATIBLE DIMMER LIST

Brand: Model
 Legrand HCL453P
 Cooper 9531AW, DAL06P, SLC03P
 Leviton 6615, 6674, DSL06-1LZ, DSM10-1LZ, IPE04-1LZ, IPL06
 Lutron CTCL-153P, DVCL-153P, DVCL-253P, DVELV-300P, MACL-153P, NTELV-600, PD-6WCL, SELV-300P

*NOTE: The above table shows dimmers that have been tested and have demonstrated proper operation under normal conditions. Each installation being unique, various factors such as load, common neutrals or other electrical products on the circuit can, in certain instances, cause variance in system performance. Read and comply to the dimmer installation instructions. Consult dimming system manufacturer for additional support in operation. Standard recommends to use dimmers designed to work with LED products. Older dimmers designed for incandescent products may cause erratic operation. Do not mix products of different wattages or types on the same dimming circuit. Some dimmers may require more than one product for stable operation. The maximum number of products is determined by the dimmer wattage rating with LEDs. Be careful, these dimmers have different ratings depending on the product type. Again, refer to the dimmer installation instructions.

Qty	Description	Price

I accept the specifications of the luminaire configuration mentioned above.

Name: _____
 Company: _____
 Signature: _____

Date: _____

Data is based upon tests performed in a controlled environment and representative of relative performance. Actual performance can vary depending on operating conditions. Specifications are subject to change without notice.