

LED CEILING LUMINAIRE INSTALLATION INSTRUCTIONS

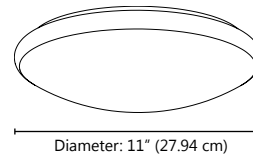

Order code	Description	Watts (W)	Volts (V)	Colour temp.	Shape	Size
63298	LED/CL11/15W/30K/FM/RND/STD	15	120	3000 K	Round	11" (27.94 cm)
63299	LED/CL11/15W/40K/FM/RND/STD	15	120	4000 K	Round	11" (27.94 cm)
63302	LED/CL14/25W/30K/FM/RND/STD	25	120	3000 K	Round	14" (35.56 cm)
63303	LED/CL14/25W/40K/FM/RND/STD	25	120	4000 K	Round	14" (35.56 cm)

Operating temperature: -10°C/44°F to 40°C/113°F

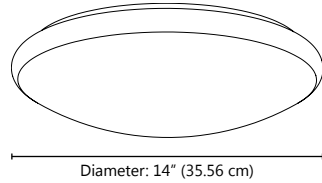

IMPORTANT - READ ALL INSTRUCTIONS BEFORE INSTALLATION

- Installation and maintenance must be performed by licensed electricians only.
- To avoid risk of electric shock, make sure to turn off main power switch prior to installation or maintenance.
- Must be installed in compliance with National Electrical Code (NEC) in the US or Canadian Electrical Code in Canada.
- Ensure input voltage and frequency are compatible with the fixture. Check product manual for power requirements prior to installation.

WARNING: Risk of electric shock. Suitable for damp locations.

- Must be grounded
- Minimum 90 °C supply conductors
- Surface mounted
- This product must be installed in accordance with the applicable installation code by a person familiar with the construction and operation of the product and the hazards involved.

ELECTRICAL COMPONENTS AND CHARACTERISTICS

- Integral, high efficiency driver and power supply
- Universal AC input voltage (120 V)
- Nominal power factor: 0.95
- Dimming: Yes (see dimmer list)

HOW TO INSTALL (MOUNTING AND ELECTRICAL)

1. Before beginning assembly, installation or operation of product, make sure all parts are present.
2. Remove diffuser by twisting out of plate (see figure 1).

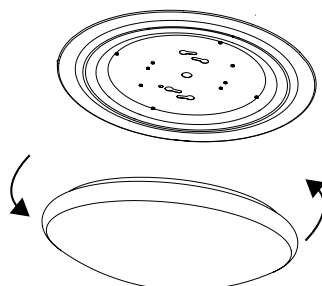

Figure 1

LED CEILING LUMINAIRE INSTALLATION INSTRUCTIONS



3. Install electrical box screws into the junction box (see figure 2 & 3).

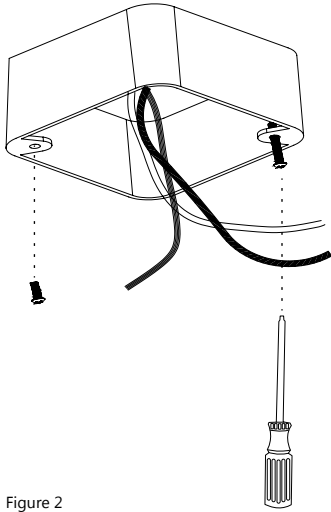

Figure 2

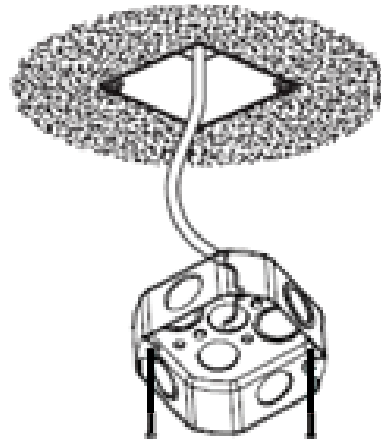

Figure 3

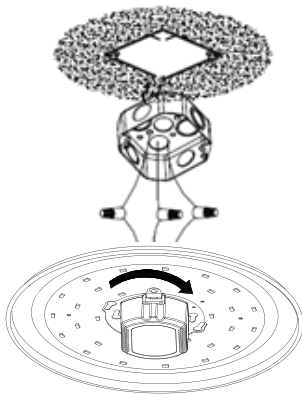

Figure 4

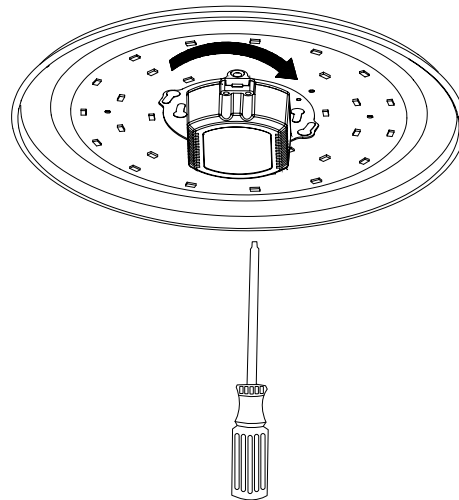

Figure 5

4. Connect the black and white wires of the luminaire with two wires of the same color from the junction box with wire caps. Connect the grounding wire of the luminaire with the one from the junction box with wire cap (figure 4)
5. Put the luminaire plate across the screw of the lock (seen in figure 2) then rotate luminaire plate clockwise and lock it tightly with the screw lock (figure 5) Securely mount the fixture plate to the junction box.

LED CEILING LUMINAIRE INSTALLATION INSTRUCTIONS



6. Mount the diffuser and twist into place (figure 1).

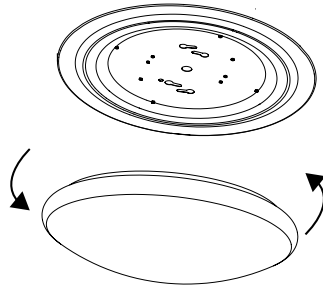

Figure 1

7. Turn on power and turn on the light switch to activate the luminaire.

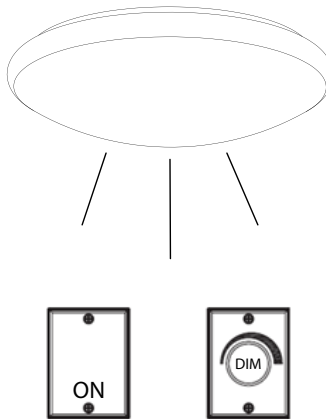

Figure 7

Maintenance:

1. Clean and maintain the luminaire regularly
2. When cleaning, use a soft cloth with non-abrasive detergent and wipe dry with a clean soft cloth
3. Do not use any cleaners that contain alcohol, harsh chemicals or pesticides
4. When cleaning inside the luminaire, turn off the power, and do not spray liquid cleaner directly on the LEDs, LED driver or wiring.

Recommended Dimmers:

Although this product is compatible with most common residential type dimmers, dimming performance varies from dimmer to dimmer. Dimmer settings (for dimmers with brightness range adjustments) and the number of LED modules installed on the circuit can affect dimming performance.

- Cooper: DAL06P, SAL06P and SLC03P
- Leviton: Decora - 6674 and Illuma Tech IPL06
- Lutron: Maestro MACL-153P, Diva DVCL-153P, Contour CTCL-153P

Some dimmers have produced a reduced dimming range or exhibit a start-up flash.